

# A.R.I. D-43



Waterworks

## Combination Air Valve **PATENTED**

### Description

A.R.I. D-043 Series, is a reduced bore Combination Air Valve. Installed on liquid transmission systems, the Air Valve is designed to improve hydraulic operation by protecting the pipeline, increasing pipeline efficiency and reducing energy requirements.

### Installation

- Pump stations: after the pump and after the check valve
- Downstream (after) and upstream (before) of shut-off valves
- After deep-well pumps
- On long constant-sloped pipeline segments
- At peaks along the pipeline and at peaks relative to hydraulic gradient
- At end lines
- Before water meters
- On strainers and filters

### Operation

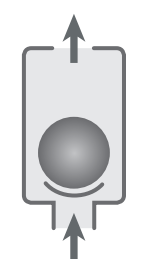

Air Discharge



Air Intake



Automatic  
Air Release



One Way out



Non Slam

## Features and Benefits

Reliable operation	reduces water hammer impact, saves energy and increases system efficiency
Dynamic design	high capacity air discharge
One-piece lightweight body	lessens the chance of leaks and vandalism
Screened threaded outlet	insect-proof, for vent pipe connection
All internal operating parts - specially selected materials	non-corrosive and durable
Automatic air release orifice	high flow air release, lessens obstruction by debris
Minimum down-time for maintenance	2" -3" - all operating parts in one replaceable cartridge 4"- 8" – automatic air release component maintained within the air valve
Rolling seal	leak-free sealing over wide range of pressure differentials
Built-in drainage outlet	hygienic, drains surplus water above the sealing mechanism
ATEX certified air valves 	certification is conditional on the customer connecting the designated part on the product to a dedicated ground connection point.

## Technical Specifications

Size range	2" –8"
Sealing pressure range	2"      0.1-10 bar      (PN10) 3"-8"    0.1-16 bar      (PN16)
Testing pressure	1.5 times maximum working pressure
Temperature	Maximum working temperature: 60° C. Maximum intermittent temperature: 90° C.
Metal Valve Coating	Fusion bonded epoxy coating in compliance with standard DIN 30677-2

Upon ordering, please specify: model, size, working pressure, thread/ flange standard and type of liquid

## Valve Selection Options

Valve connection	Threaded male or female BSPT/NPT (2", 3"), Flanged ends to meet various requested standard (3"-8")
Standard materials	Reinforced nylon, cast ductile iron body
Optional Add-on Components	One-way, Out-only attachment, allows for air discharge only, prevents air intake Adjustable Non-Slam disc, can also be optionally retrofitted on existing D-43 air valves.
Additional Product Configurations	SB Underground Air Valve System

La válvula instalada debajo de la ventosa debe estar completamente abierta para prevenir daños o desperfectos y asegurar que la válvula de aire funcione según las especificaciones.

Para obtener las instrucciones completas de instalación se recomienda consultar el manual IOM.

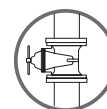

## Non-Slam Add-on Component Data Table for Variable Orifices

Size	Number of orifices	Discharge orifice (mm)	Total NS area (mm <sup>2</sup> )	NS orifice (mm)	Switching point (bar)	Flow at 0.4 bar (m <sup>3</sup> /h)
------	--------------------	------------------------	----------------------------------	-----------------	-----------------------	-------------------------------------

### Nylon Models

2" (50mm)	1 orifice	34	12.6	4	Spring loaded normally closed	24
3" (50mm)	1 orifice	50	15.9	4.5		23
	2 orifices	50	31.8	6.4		32
	3 orifices	50	47.7	7.8		40

### Metal Models

3" (80mm)	1 orifice	50	78.5	10	0.001	65
4" (100mm)	1 orifice	80	184	15	0.004	180
6" (150mm)	1 orifice	100	397	22.5	0.005	235
8" (200mm)	1 orifice	150	884	34	0.03	725

## Dimensions and Weight

Size	Dimensions (mm)		Connections	Weight (kg)	Orifice Area (mm <sup>2</sup> )	
	max. A	B			A / V	Auto.

### Nylon Models

2" (50mm) TRH	85	245	1½" BSP F	0.5	908	11.7
3" (80mm) TRH	148	327	2" BSP/NPT F	1.5	2106	14.9
3" (80mm) FL	200	332	2" BSP/NPT F	2.2	2106	14.9

### Metal Models

3" (80mm) FL	200	367	2" BSP/NPT F	7.3	1963	13.8
4" (100mm) FL	220	467	3" BSP/NPT F	13.0	5027	13.8
6" (150mm) FL	282	537	4" BSP/NPT F	18.2	7854	13.8
8" (200mm) FL	340	757	6" Grooved	43.6	18250	14.9

FL - Flanged THR - Threaded

### NOTE

The discharge elbow can be set in four directions.

Dimension A in the picture and in the table shows the maximum product width. This width can be reduced by changing the cover direction. All product weights are approximate, due to the differences in flange standards, materials and variable accessories.

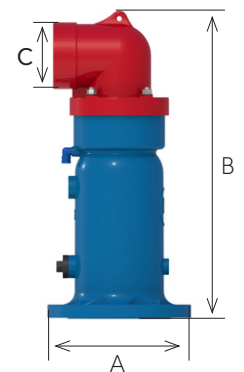

## Flow Charts

### D-43 Nylon Models

Air & Vacuum Flow Rate

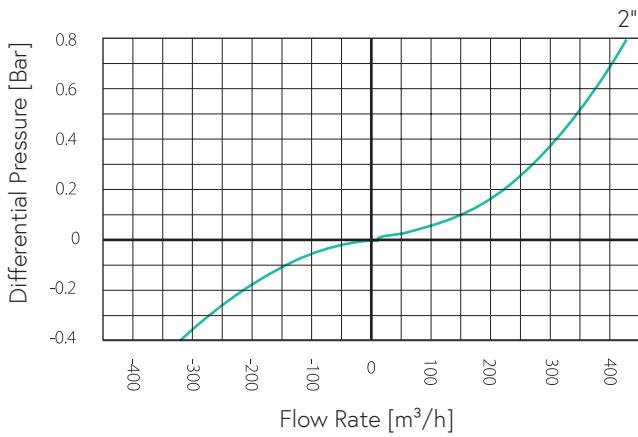

Automatic Air Release Flow Rate

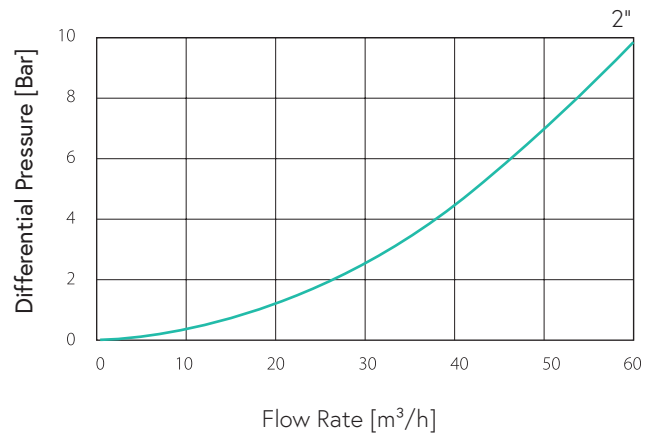

Air & Vacuum Flow Rate

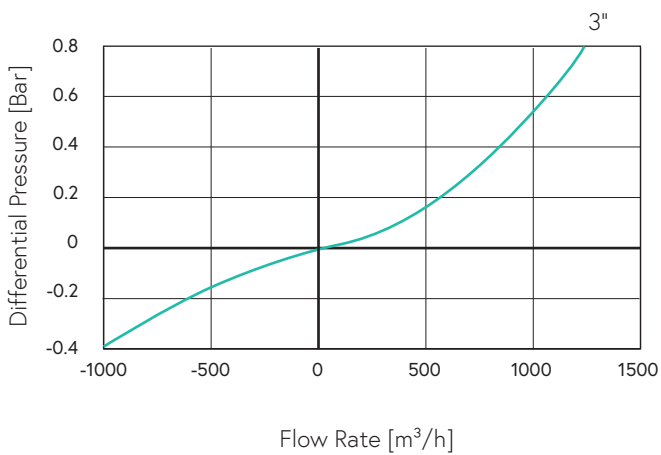

Automatic Air Release Flow Rate

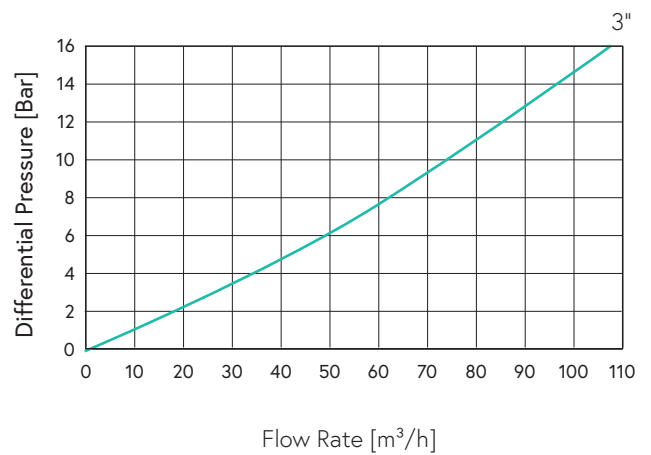

## D-43 Metal Models

Air & Vacuum Flow Rate

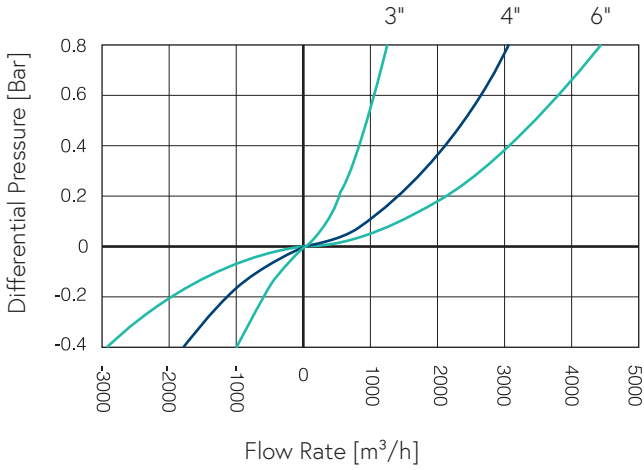

Automatic Air Release Flow Rate

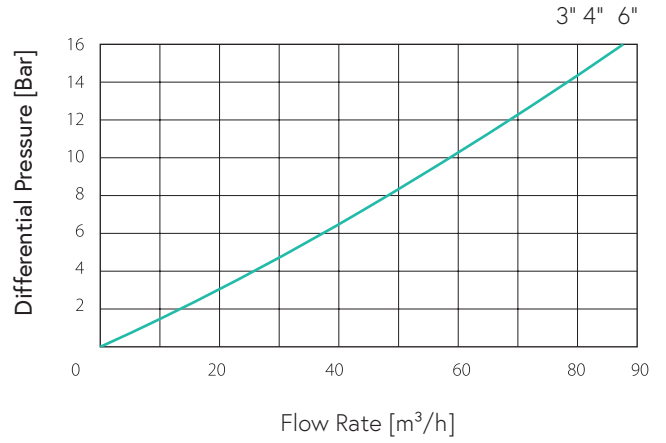

Air & Vacuum Flow Rate

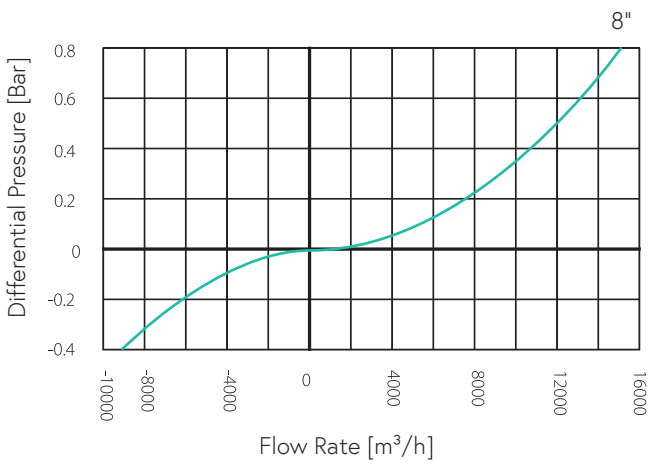

Automatic Air Release Flow Rate

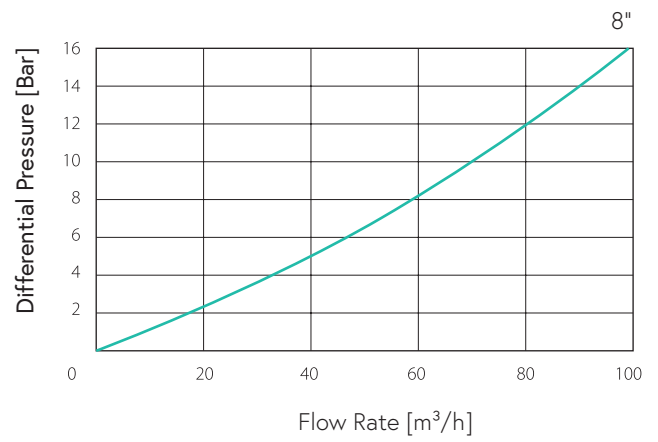

## D-43 NS Nylon Models

Adjustable NS Check Valve 2"

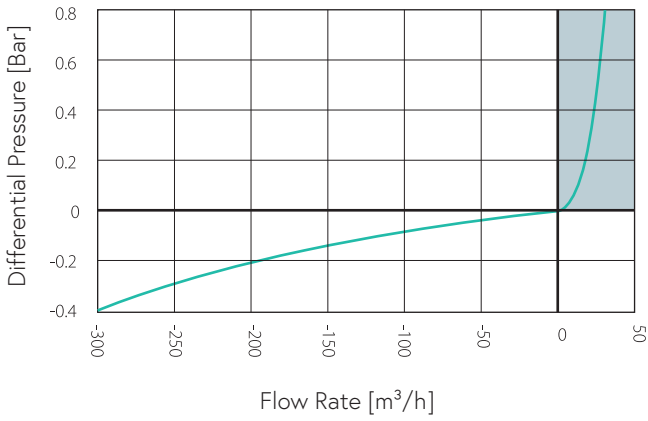

Adjustable NS Check Valve 2"

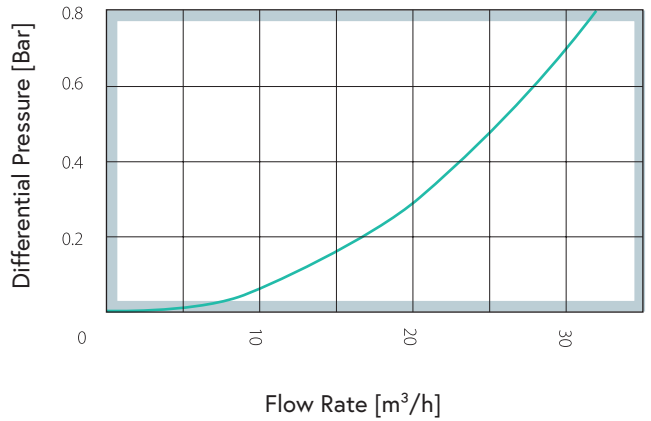

Adjustable NS Check Valve 3"

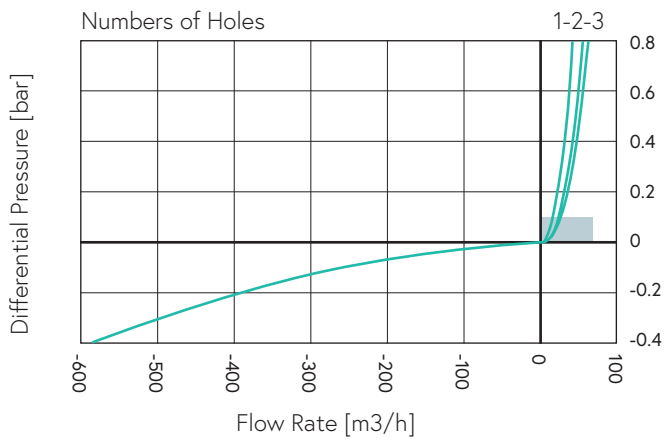

Adjustable NS Check Valve 3"

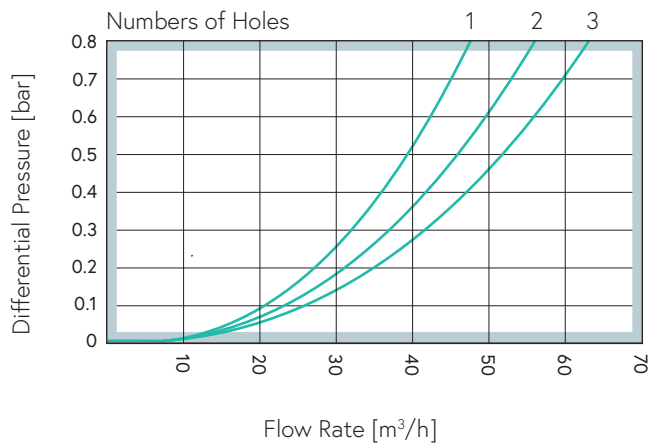

## D-43 NS Metal Models

Air & Vacuum Flow Rate

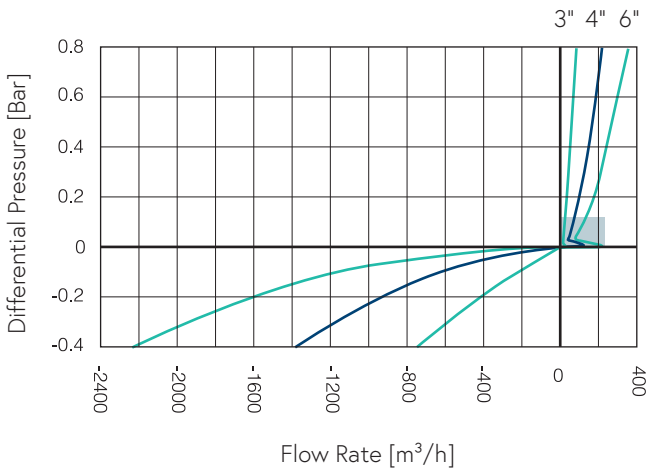

Air Discharge Switching Region

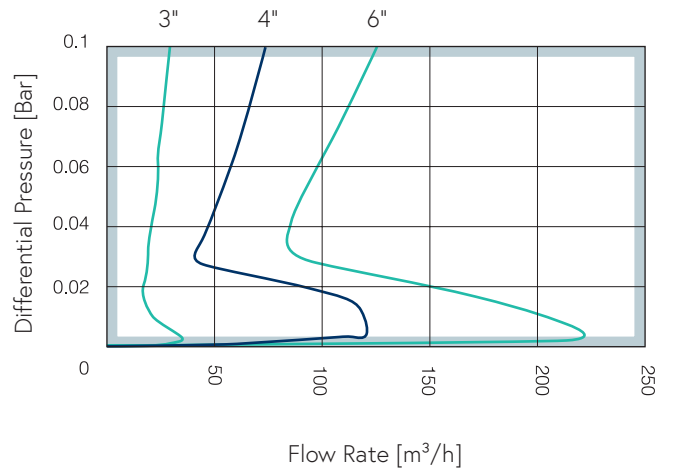

Air & Vacuum Flow Rate

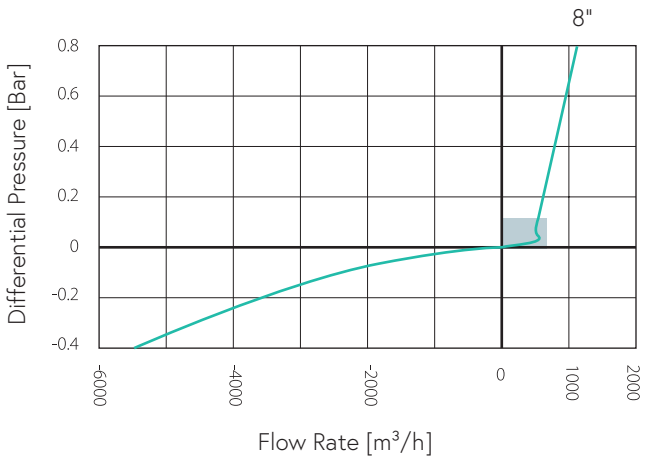

Air Discharge Switching Region

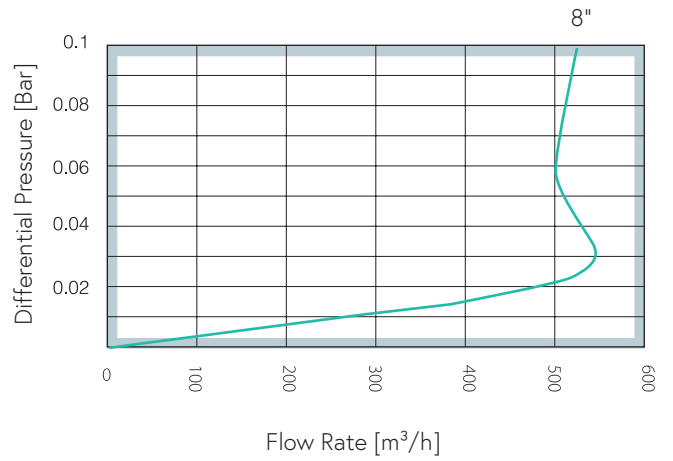

## Parts List and Specification | Nylon 2"

No.	Part	Material
1	Discharge Elbow Assembly	
1a.	Discharge Elbow	Polypropylene
1b.	O-rings	Buna-N
1c.	Non-Slam Component (Optional)	Reinforced Nylon / Polypropylene + Acetal + Stainless Steel
2	Body	Reinforced Polypropylene
3	Air Release / Air & Vacuum Assembly	
3a.	Air & Vacuum Seal	EPDM
3b.	Air Release Cover	Acetal
3c.	Rolling Seal	EPDM
3d.	Float	Polypropylene
3e.	Float Lock	Polypropylene





## Parts List and Specification | Nylon 3"

No.	Part	Material
1	Cover Assembly	
1a	Cover	Reinforced Nylon
1b	NS	Reinforced Nylon
2	Air Release / Air & Vacuum Assembly	
2a	Air & Vacuum Seal	EPDM
2b	Air Release Cover	Reinforced Nylon
2c	Rolling Seal	EPDM
2d	Float	Polypropylene
2f	O-ring	NBR
3	Body	Reinforced Nylon
4	Optional Flange Assembly	
4a	O-ring	NBR
4b	Flange	Reinforced Nylon



## Parts List and Specification | Metal 3"

No.	Part	Material
1	Discharge Elbow Assembly	
1a.	Discharge Elbow	Polypropylene
1b.	Seal	Buna-N
2	Body Assembly	
2a.	Optional - Non Slam Disc	Reinforced Nylon
2b.	Body	Ductile Iron
2c.	Drain Outlet	Polypropylene
2d.	Pressure Release Plug	Reinforced Nylon
3	Air Release / Air & Vacuum Assembly	
3a.	Air & Vacuum Seal	EPDM
3b.	Air Release Cover	Acetal
3c.	Rolling Seal	EPDM
3d.	Float	Polypropylene
4	Seat Assembly	
4a.	Float Seat	Acetal
4b.	Snap Ring	Reinforced Nylon



## Parts List and Specification | Metal 4" - 6"

No.	Part	Material
1	Discharge Elbow Assembly	
1a.	Discharge Elbow	Polypropylene
1b.	Seal	Buna-N
2	Body Assembly	
2a.	Optional - Non Slam Disc	Reinforced Nylon
2b.	Body	Ductile Iron
2c.	Drain Outlet	Polypropylene
2d.	Pressure Release Plug	Reinforced Nylon
3	Air Release Assembly	
3a.	Cover	Acetal
3b.	O-ring	EPDM
3c.	Rolling Seal	EPDM
3d.	Air Release Float	Polypropylene
4	Air & Vacuum Assembly	
4a.	Air & Vacuum Seal	EPDM
4b.	Air & Vacuum Float	Polypropylene
5	Seat Assembly	
5a.	Float Seat	Acetal
5b.	Snap Ring	Reinforced Nylon

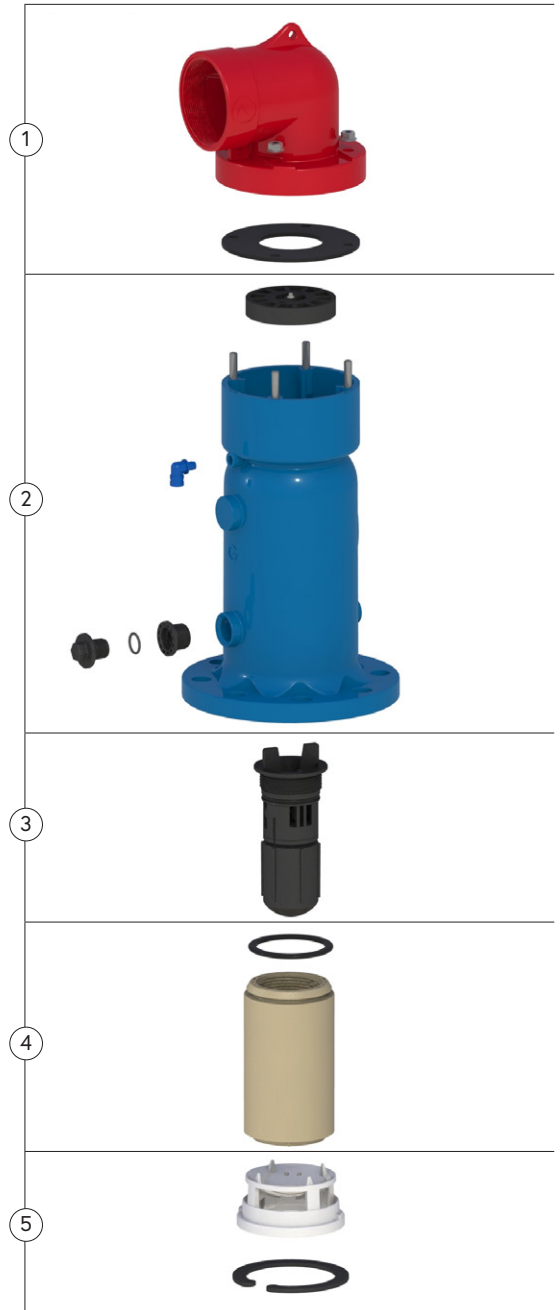

## Parts List and Specification | Metal 8"

No.	Part	Material
1	Discharge Elbow Assembly	
1a.	Flange (optional)	Polypropylene / Steel
1b.	Locking Ring (optional)	Acetal
1c.	O-ring (optional)	EPDM
1d.	Discharge Elbow	Polypropylene
1e.	Lifting Ring	Stainless Steel 316
1f.	Seal	Buna-N
2	Body Assembly	
2a.	Optional - Non Slam Disc	Reinforced Nylon
2b.	Body	Ductile Iron
2c.	Drain Outlet	Polypropylene
2d.	Pressure Release Plug	Reinforced Nylon
3	Air Release Assembly	
3a.	Cover	Reinforced Nylon
3b.	O-ring	EPDM
3c.	Rolling Seal	NBR
3d.	Air Release Float	Foamed Polypropylene
4	Air & Vacuum Assembly	
4a.	Air & Vacuum Seal	EPDM
4b.	Air & Vacuum Float	Reinforced Polypropylene
5	Seat Assembly	
5a.	Float Seat	Acetal
5b.	Snap Ring	Acetal

