

A.R.I. D-46



Waterworks

Combination Air Valve for High Flow **PATENTED**

Description

A.R.I. D-46 Series, is a full-bore Combination Air Valve. Installed on liquid transmission systems, the Air Valve is designed to improve hydraulic operation by protecting the pipeline, increasing pipeline efficiency and reducing energy requirements. The Air Valve provides high-capacity air release and intake.

Installation

- Pump stations: after the pump and after the check valve
- Downstream (after) and upstream (before) of shut-off valves
- After deep-well pumps
- On long constant-sloped pipeline segments
- At peaks along the pipeline and at peaks relative to hydraulic gradient
- At end lines
- Before water meters
- On strainers and filters

Operation

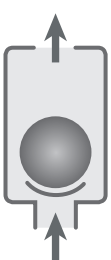

Air Discharge



Air Intake



Automatic
Air Release



One Way out



Non Slam

Features and Benefits

Reliable operation	reduces water hammer impact, saves energy and increases system efficiency
Dynamic design	high capacity air discharge
One-piece lightweight body	lessens the chance of leaks and vandalism
Screened threaded outlet	insect-proof, for vent pipe connection
All internal operating parts - specially selected materials	non-corrosive and durable
Automatic air release orifice	high flow air release, lessens obstruction by debris
Minimum down-time for maintenance	2" - all operating parts in one replaceable cartridge 3" - 6" - automatic air release component maintained within the air valve
Rolling seal	leak-free sealing over wide range of pressure differentials
Built-in drainage outlet	hygienic, drains surplus water above the sealing mechanism
ATEX certified air valves 	certification is conditional on the customer connecting the designated part on the product to a dedicated ground connection point.

Technical Specifications

Size Range	2" -6"
Sealing pressure range	0.1-16 bar (PN 16) Testing pressure: 1.5 times maximum working pressure
Temperature	Maximum working temperature: 60° C Maximum intermittent temperature: 90° C
Metal valve coating	Fusion bonded epoxy coating in compliance with standard DIN 30677-2

Upon ordering, please specify: model, size, working pressure, thread / flange standard and type of liquid

Valve Selection Options

Valve connection	Threaded male BSPT/NPT (2"), Flanged ends to meet various requested standard (2"-6")
Standard materials	Reinforced nylon, cast ductile iron body
Optional Add-on Components	One-way, Out-only attachment, allows for air discharge only, prevents air intake Adjustable Non-Slam disc, can also be optionally retrofitted on existing D-46 air valves.
Additional Product Configurations	SB Underground Air Valve System
Models	Elbow Outlet Models, Screen Cover Models

The valve installed under the air valve must be fully open to prevent damage or malfunction and ensure performance within the specifications of the air valve.

For complete installation instructions, please refer to the IOM document.

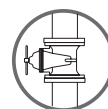

Dimensions and Weight

Size	Dimensions (mm)		Connections	Weight (kg)	Orifice Area (mm ²)		
	max. A	B			C	A / V	Auto.
Nylon Models							
2" (50mm) TRH	150	327	2" BSP/NPT F	1.4	2122	15.0	
2" (50mm) FL	170	367	2" BSP/NPT F	1.9	2122	15.0	
Metal Models - Elbow Outlet							
2" (50mm) FL	202	336	2" BSP/NPT F	7.3	1963	15.0	
3" (80mm) FL	200	467	3" BSP/NPT F	13.0	5027	13.8	
4" (100mm) FL	220	537	4" BSP/NPT F	18.2	7854	13.8	
6" (150mm) FL	362	757	6" Grooved	43.6	18250	15.0	
Metal Models - Screen Cover Outlet							
2" (50mm) FL	165	301	NA	6.8	1963	15.0	
3" (80mm) FL	202	375	NA	12.8	5027	13.8	
4" (100mm) FL	235	425	NA	17	7854	13.8	
6" (150mm) FL	323	594	NA	43	18250	15.0	

FL - Flanged THR - Threaded

NOTE

The cover assembly with the discharge elbow can be set in four directions. Dimension A in the picture and in the table shows the maximum product width. This width can be reduced by changing the cover direction.

All product weights are approximate, due to the differences in flange standards, materials and variable accessories.

Flow Charts

Automatic Air Release Flow Rate

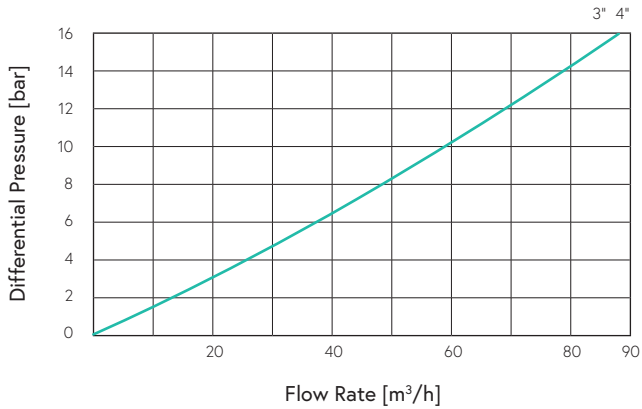

Automatic Air Release Flow Rate

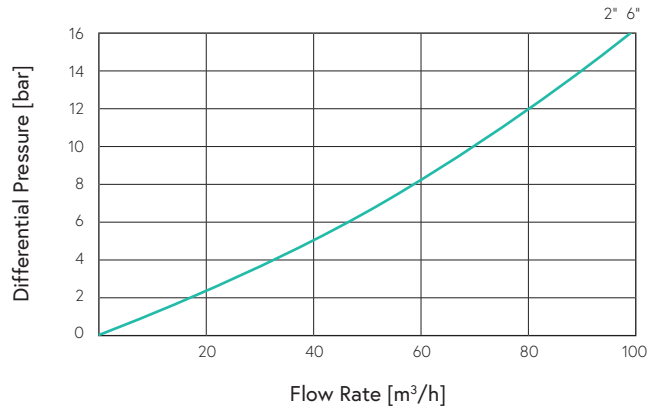

Elbow Outlet Models

Air & Vacuum Flow Rate

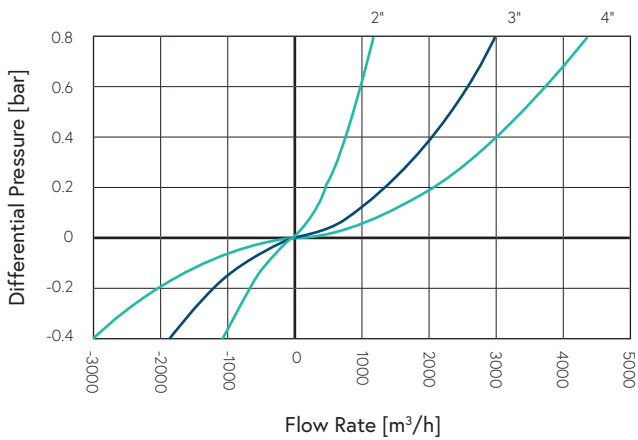

Air & Vacuum Flow Rate

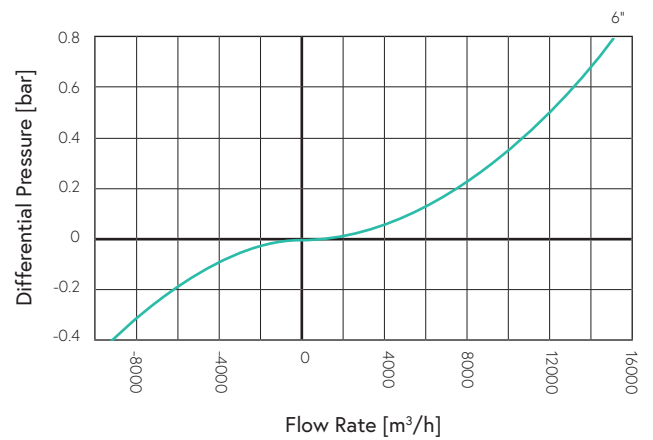

Screen Cover Outlet Models

Air & Vacuum Flow Rate

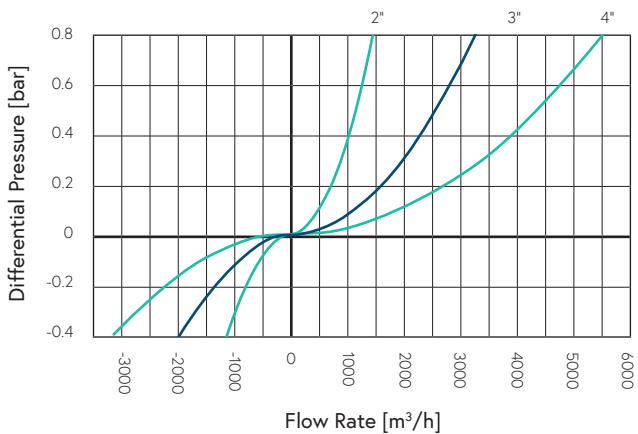

Air & Vacuum Flow Rate

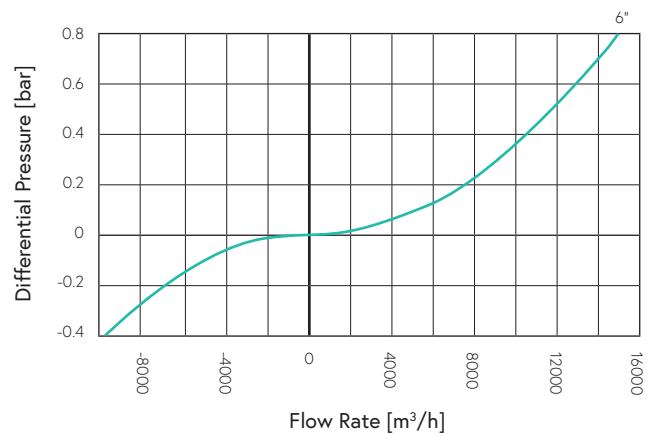

Non-Slam Add-on Component Data Table for Variable Orifices

Nylon Models

Size	Number of orifices	Discharge orifice (mm)	Total NS area (mm ²)	NS orifice (mm)	Switching point (bar)	Flow at 0.4 bar (m ³ /h)
2" (50mm)	1 orifice	50	15.9	4.5	Spring loaded normally closed	23
	2 orifices	50	31.8	6.4		32
	3 orifices	50	47.7	7.8		40

Metal Models

Size	Discharge orifice (mm)	Total NS area (mm ²)	NS orifice (mm)	Switching point (bar)	Flow at 0.4 bar (m ³ /h)
2" (50mm)	50	78.5	10	0.007	65
3" (80mm)	80	184	15	0.004	180
4" (100mm)	100	397	22.5	0.005	235
6" (150mm)	150	884	34	0.03	725

Nylon Model

Adjustable NS Check Valve

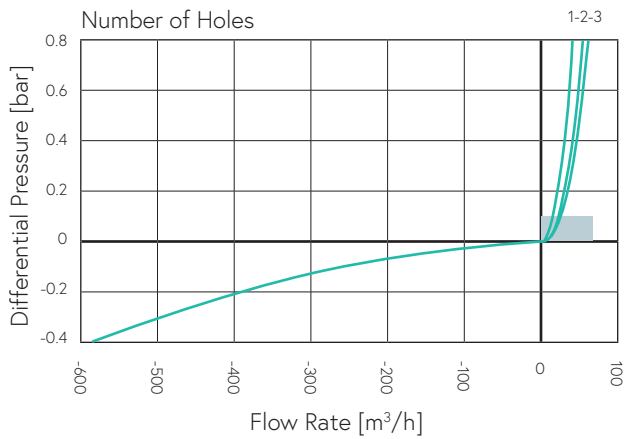

Adjustable NS Check Valve

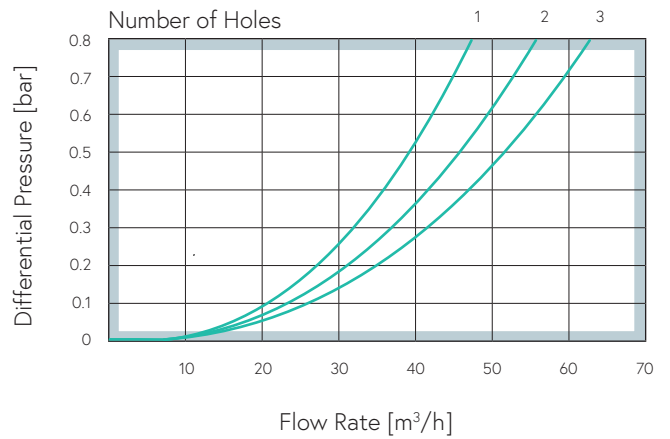

Metal Models - Elbow Outlet

Air & Vacuum Flow Rate

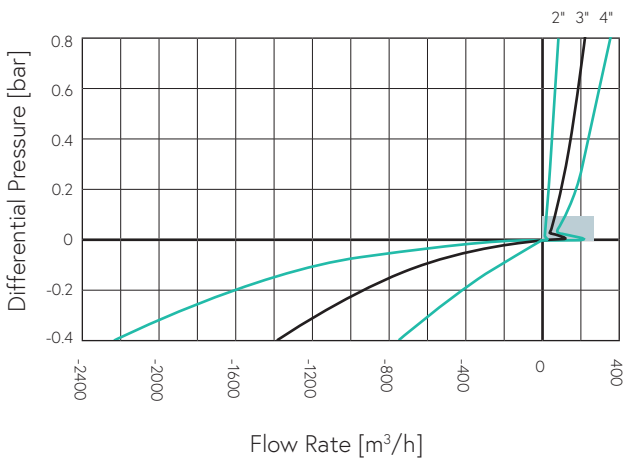

Air Discharge Switching Region

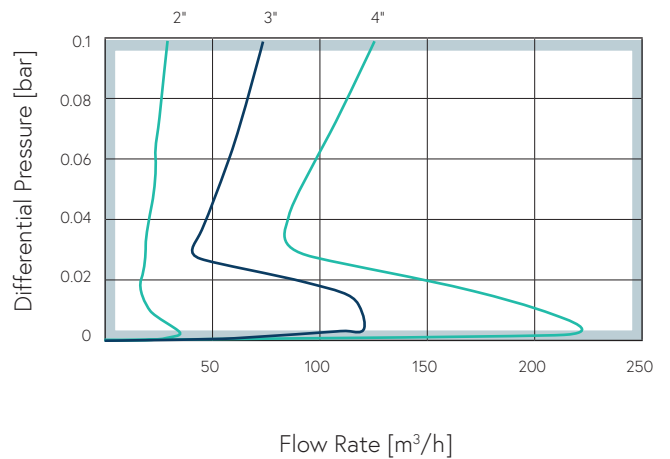

Air & Vacuum Flow Rate

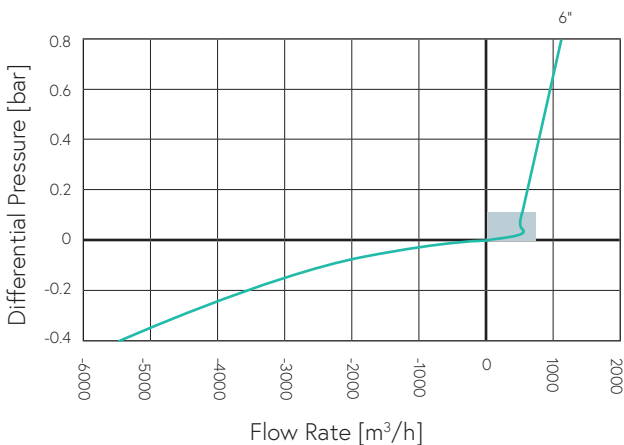

Air Discharge Switching Region

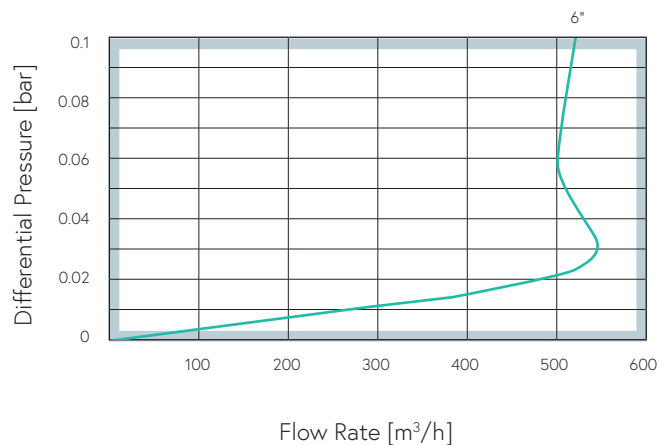

Metal Models - Screen Cover Outlet

Air & Vacuum Flow Rate

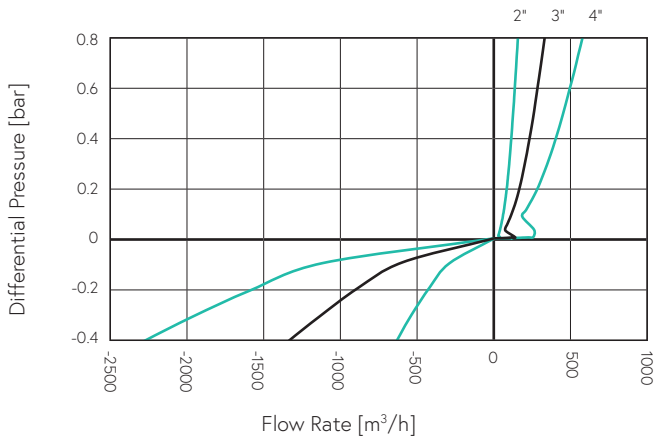

Air Discharge Switching Region

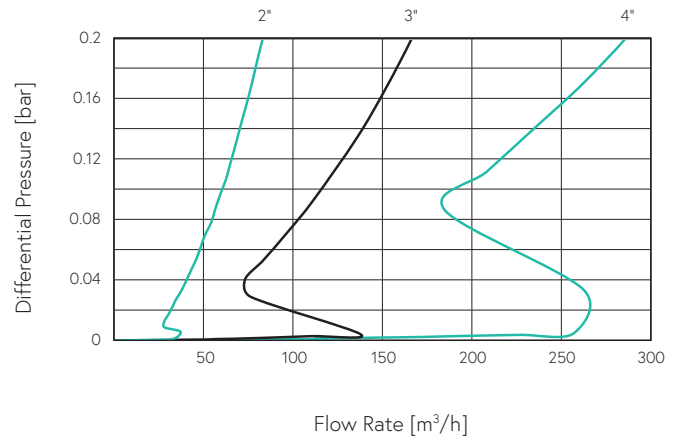

Air & Vacuum Flow Rate

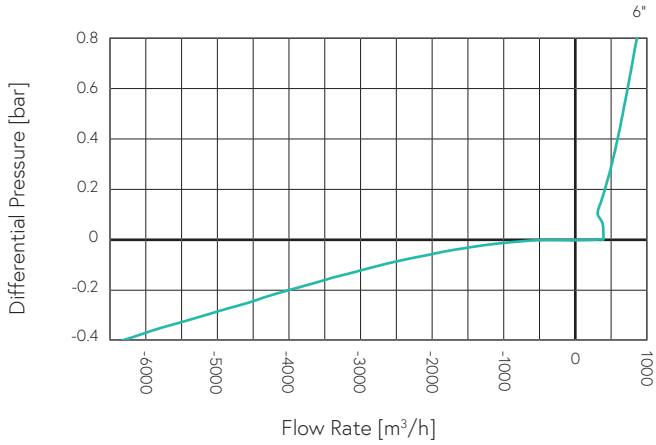

Air Discharge Switching Region

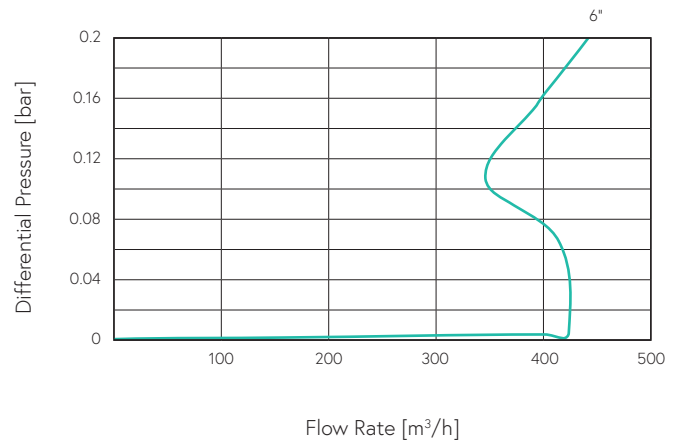

Parts List and Specification | Nylon 2"

No.	Part	Material
1	Cover Assembly	
1a	Cover	Reinforced Nylon
1b	NS	Reinforced Nylon
2	Air Release / Air & Vacuum Assembly	
2a	Air & Vacuum Seal	EPDM
2b	Air Release Cover	Reinforced Nylon
2c	Rolling Seal	EPDM
2d	Float	Polypropylene
2f	O-ring	NBR
3	Body	Reinforced Nylon
4	Optional Flange Assembly	
4a	O-ring	NBR
4b	Flange	Reinforced Nylon + Stainless Steel 316



Parts List and Specification | Metal 2"

Part	Material
1. Discharge Assembly	
1a. Discharge Elbow or Screen Cover	Polypropylene
1b. Seal	NBR
2. Body Assembly	
2a. Optional - Non Slam Disc	Reinforced Nylon
2b. Body	Ductile Iron
2c. Drain Outlet	Polypropylene
2d. Pressure Release Plug	Reinforced Nylon
3. Air Release / Air & Vacuum Assembly	
3a. Air & Vacuum Seal	EPDM
3b. Air Release Cover	Acetal
3c. Rolling Seal	EPDM
3d. Float	Polypropylene
4. Seat Assembly	
4a. Float Seat	Acetal
4b. Snap Ring	Reinforced Nylon

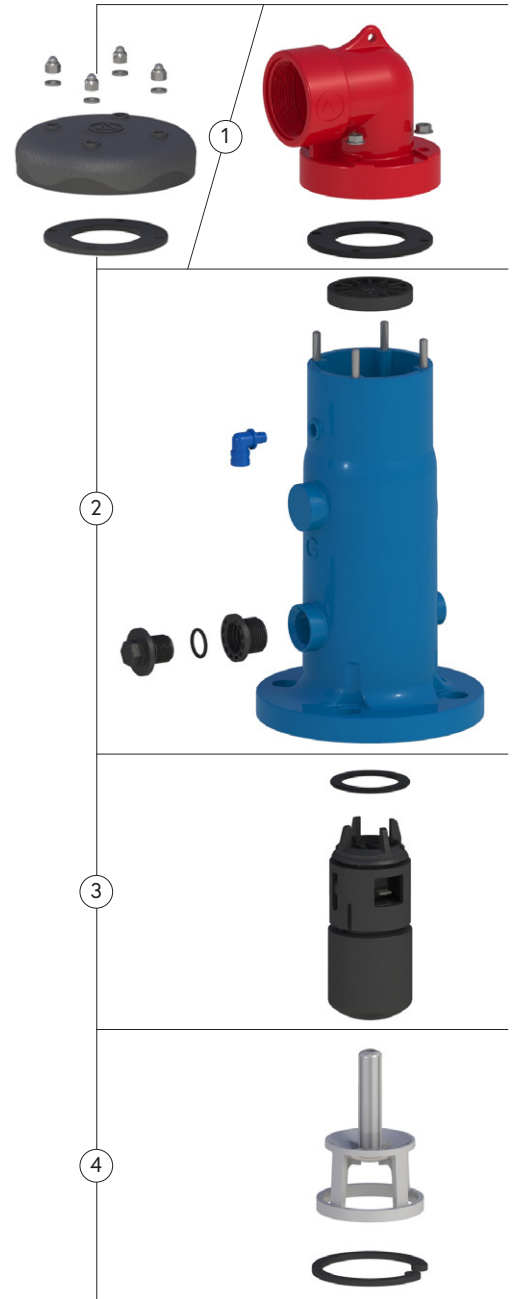

Parts List and Specification | Metal 3" 4"

Part	Material
1. Discharge Assembly	
1a. Discharge Elbow or Screen Cover	Polypropylene
1b. Seal	NBR
2. Body Assembly	
2a. Optional - Non Slam Disc	Reinforced Nylon
2b. Body	Ductile Iron
2c. Drain Outlet	Polypropylene
2d. Pressure Release Plug	Reinforced Nylon
3. Air Release Assembly	
3a. Cover	Acetal
3b. O-ring	EPDM
3c. Rolling Seal	EPDM
3d. Air Release Float	Polypropylene
4. Air & Vacuum Assembly	
4a. Air & Vacuum Seal	EPDM
4b. Air & Vacuum Float	Polypropylene
5. Seat Assembly	
5a. Float Seat	Acetal
5b. Snap Ring	Reinforced Nylon

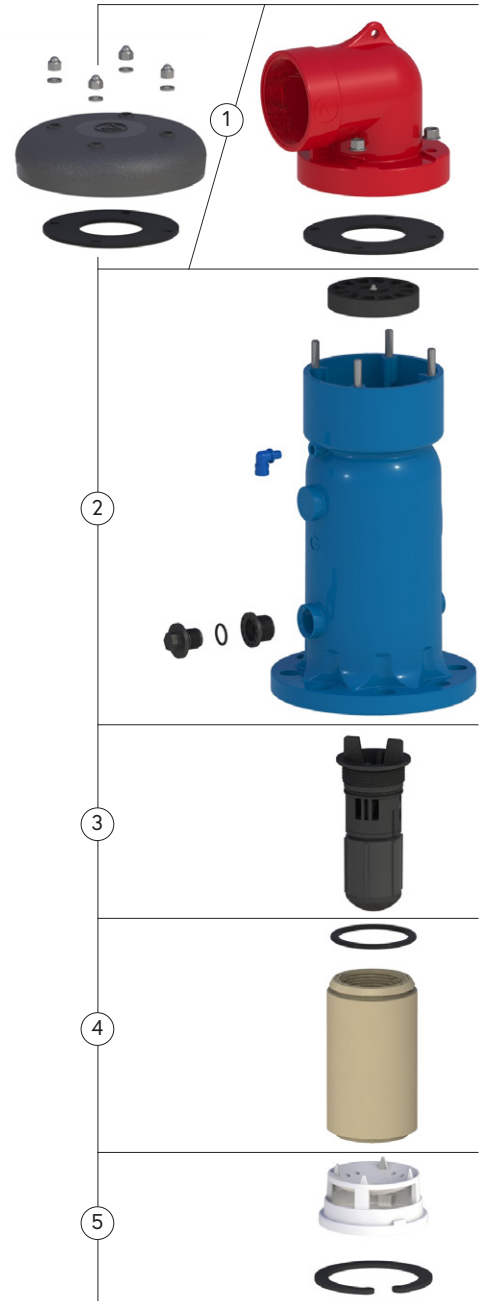

Parts List and Specification | Metal 6"

Part	Material
1. Discharge Assembly	
1a. Discharge Elbow or Screen Cover	Polypropylene
1b. Lifting Ring	Stainless Steel 316
1c. Seal	NBR
1d. Optional for Elbow Model Flange + Locking Ring + O-ring	Polypropylene / Steel + Acetal+ EPDM
2. Body Assembly	
2a. Optional - Non Slam Disc	Reinforced Nylon
2b. Body	Ductile Iron
2c. Drain Outlet	Polypropylene
2d. Pressure Release Plug	Reinforced Nylon
3. Air Release Assembly	
3a. Cover	Reinforced Nylon
3b. O-ring	EPDM
3c. Rolling Seal	NBR
3d. Air Release Float	Foamed Polypropylene
4. Air & Vacuum Assembly	
4a. Air & Vacuum Seal	EPDM
4b. Air & Vacuum Float	Reinforced Polypropylene
5. Seat Assembly	
5a. Float Seat	Acetal
5b. Snap Ring	Acetal

