

HIGH CAPACITY AUTOMATIC AIR RELEASE VALVE MODEL S-022-HC

The following is a step by step narrated description of the A.R.I. S-022-HC High Capacity Automatic Air Valve installation, operation and maintenance processes.

The S-022-HC air valve is specially designed to operate with liquids carrying solid particles in systems operating under pressure. Please consult A.R.I. for the pressure and temperature framework of this model specifications table and for other products designed for hazardous liquids systems.



TABLE OF CONTENTS

1. SAFETY INSTRUCTIONS.....	3
2. INSTALLATION	6
3. OPERATION	9
4. TROUBLE SHOOTING	9
5. PERIODIC MAINTENANCE.....	10
5.1. Preparation	10
5.2. First Stage Maintenance	10
5.3. Second Stage Maintenance.....	14
6. ASSEMBLY BOM TABLE AND DRAWING.....	24
7. A.R.I. LIMITED WARRANTY.....	26

Disclaimer

This document is an Installation, Operation and Maintenance (IOM) manual for A.R.I. Flow Control Accessories Ltd. (A.R.I.) products. The information enclosed herein contains restricted, privileged, proprietary and confidential information, intended only for usage by authorized A.R.I. technicians. If you are not a qualified technician, you must not take any action in reliance upon this document, unless otherwise permitted in writing by A.R.I.

A.R.I. has made every effort to ensure that this document is accurate; A.R.I. disclaims liability for any inaccuracies or omissions that may have occurred.

All the procedures, drawings, pictures and/or any other information provided in this document are presented as general information only; they can be altered, removed or changed without A.R.I.'s prior written approval. A.R.I. makes no commitment to update or keep the information in this document current and/or up-to-date, and reserves the right to make improvements, alterations and/or modifications to this document and/or to the products described in this document, at any time without providing any notice with respect thereto. Nothing in this Disclaimer derogates in any way whatsoever from the confidential nature of any document enclosed hereto, including for avoidance of doubt, any mistake or clerical error or other error. None of the procedures provided in this Disclaimer and/or in any document enclosed hereto may be used in any form or by any means without the prior written consent from A.R.I. If you received this Disclaimer and/or in any document enclosed hereto in error or by mistake or if this Disclaimer and/or in any document enclosed hereto is not intended for you, please notify A.R.I. in writing immediately.

A.R.I. assumes that all users understand the risks involved within this Disclaimer and/or in any document enclosed hereto.

A.R.I. accepts/assumes no liability whatsoever, whether caused by: accessing and/or relying upon this Disclaimer and/or in any document enclosed hereto including without limitation any links, procedures or materials.

A.R.I. shall **NOT** assume any liability for any costs, direct or indirect, including loss of income, loss of profits and/or goodwill, legal actions and/or damages of any kind whatsoever including any, damages accidents, equipment damage or bodily injury resulting from and/or related to any of the following:

- product has not been duly installed and thereafter maintained in strict compliance with its designated Maintenance Instructions and/or any other installation and operation manuals provided by A.R.I. for the product and/or applicable ordinances and/or codes;
- Repairs made in and to the products by personnel not authorized by A.R.I.
- Maintenance or repairs using parts or components other than those specified by A.R.I. and in their original condition.
- Operating the products in ways other than the operating procedures described in the manuals provided by A.R.I., or resulting from not following the cautionary remarks and warnings in the product manual.
- Improper storage, workplace conditions and environmental conditions which do not conform to those stated in the Product manual.
- Fires, earthquakes, floods, lightning, natural disasters, or acts of God.

A.R.I. does not warrant and hereby disclaims any express or implied warranties that the product will work properly in environments and applications other than its original design purpose, and makes no warranty and representation, either implied or expressed, with respect to the quality, performance, merchantability, or fitness for any other particular purpose.

Except as provided herein and to the full extent permitted by law, A.R.I. shall not be responsible and/or liable for direct, special, incidental or consequential damages or loss resulting from any breach of the above or under any other legal theory.

This document does not replace any certified drawing, procedure or information provided by A.R.I. in reference to a specific customer, site or project. All rights reserved.

1. SAFETY INSTRUCTIONS

General

1. A.R.I. products always operate as components in a larger system. It is essential for the system designers, installers, operators and maintenance personnel to comply with all the relevant safety standards.
2. Installation, operation or maintenance of the product should be done only by qualified workers, technicians and/or contractors using only good engineering practices, complying with and observing all conventional safety instructions in order to minimize risk and/or danger and/or hazard to workers, the public or to property in the vicinity in accordance with all relevant local standards.
3. Extra safety considerations should be taken with hot and hazardous liquids or in hazardous environments' applications to avoid bodily/physical harm and damage to public or private property.
4. All individuals installing operating and/or handling the products including all workers should at all times adhere with the occupational safety and health (OSH) instructions and wear safety helmets, goggles, gloves, and any other personal safety equipment required by the local standards and regulations.
5. Use only appropriate standard tools and equipment operated by qualified operators when installing, operating and maintaining the product.
6. Prior to installation, operation, maintenance or any other type of action carried out on the product, read carefully the safety, installation and operation instructions of the product.
7. **Please note:**
 - Pressurized fluid and/or gas may be discharged from the product without prior warning. Make sure that the product's outlet port is not directed toward electrical elements (pumps) or people.
 - The pressurized fluid and/or gas that can be discharged from the product may create high noise levels. Take this into consideration when installing the product in areas sensitive to noise.
8. Always open and close valves slowly and gradually.
9. Please note that the maximum working pressure indicated at the product's specifications table doesn't include pressure changes caused by water hammer and pressure surge effects. Use the product only according to its designated pressure rate specifications.
10. Use the product only for its intended use as designed by A.R.I. Any misuse of the product may lead to undesired damages and may affect your warranty coverage. Please consult with A.R.I. prior to any non regular use of this product and make no change or modification to the product without a prior written consent to be provided by A.R.I. at A.R.I.'s sole discretion.
11. Please note that A.R.I. shall **NOT** assume any liability with respect to any damage losses and/or expenses caused to any person and/or property whatsoever unless the product has been duly installed and thereafter maintained in strict compliance with its designated maintenance Instructions and/or any other installation and operation manuals provided by A.R.I. for the product and/or applicable ordinances and/or codes.

Handling

1. Shipping and handling the product must be done in a safe and stable manner and in accordance with the relevant standards and regulations.
2. For lifting and positioning the product, use only approved lifting equipment operated by authorized employees and contractors.
3. Prior to the installation visually verify that the product was not damaged during shipment to the installation site.

Installation

1. Install the product according to the detailed Installation Instructions provided with it by A.R.I. and according to the description given in this manual.
2. The user should install a manual Isolation Valve under the product's inlet port.
3. In all installation sites the user should enable good visibility and verify that the work and auxiliary equipment used are done in accordance with the relevant local authorized standards. Extra safety considerations should be taken on hazardous environment sites.
4. Check and re-tighten the bolts connecting the product to the pipeline during commissioning and before operating the product for the first time.

Commissioning and operation

1. Read carefully the operation instructions prior to any attempt to operate the product.
2. Observe the safety stickers on the product and never perform any operation contradicting the instructions given.
3. In order to achieve maximum performance and smooth operation of the product it is crucial to perform the startup and first operation procedures exactly as described in this manual.
4. In cases where formal commissioning procedure is required it should be done by an authorized A.R.I. technician prior to the first operation of the product.

Maintenance

Before any maintenance or non regular operation please read the following:

1. Servicing the product should be done only by qualified technicians for this type of work.
2. Make sure that you know the exact type of the system's fluid. Act accordingly and comply with all the relevant standards and regulations set for handling this type of fluid.
3. Before disconnecting the product from the system and before releasing the residual pressure do **NOT**:
 - loosen or unscrew the product bolts;
 - remove any protection cover;
 - open any service port.
4. Before any maintenance or non regular operation shut off the Isolation valve and release the residual pressure:
 - A. For air valves with pressure release outlet, slowly open the pressure release plug or the ball valve and make sure that all pressure is released. Please note that some air release valves, especially the waste water models, may contain significant volume of compressed gas with accumulated energy!
 - B. For air valves without a pressure release outlet, slowly unscrew the flange bolts until all the pressure is released from the valve.
5. Make sure the air valve is empty of all liquid prior to commencing maintenance.
6. Remove the product from the line only after ensuring that internal pressure has been released.
7. Place warning signs around the work area as required by the local standards and procedures.
8. Inspect the product's safety stickers and replace any damaged or faded sticker.
9. Manual cleaning of the product and/or its components using high water pressure or steam should be performed in accordance with its specific cleaning instructions, the local standards and regulations and without endangering the operator or the vicinity
10. Manual cleaning of product and/or its components using acid or other chemical agents should be performed in accordance with the specific cleaning instructions, the relevant safety instructions for using that chemical as given by its supplier, the local standards and regulations and without endangering the operator or his vicinity.
11. For products used in potable water systems if it is required to disinfect the product, do so according to the local water authority standards and regulations before putting the product into service.

Before returning to regular operation

1. Re-assemble any protection covers or protection mechanisms removed during service or maintenance operations.
2. Make sure that all the tools, ladders, lifting devices, etc. used during the maintenance procedures are taken away from the product area and stored.
3. Remove grease and fat material residues in order to avoid slipping.
4. In order to return the product to regular operation, follow the First Start-up Operation instructions as detailed in your user manual.

2. INSTALLATION

Important: Before performing any work on the air valve make sure that all workers on site are familiar with the safety instructions and the relevant local and general safety instructions and work regulations.

2.1. Installation Recommendations



Single Air Valve on an Isolating Valve at 45° to Air Valve outlet



Two Air Valves on a shared Isolating Valve. Air Valves outlets face outward and the Isolating Valve at 45° to Air Valve outlets



Two Air Valves on an Air Trap with separate Isolating Valves. Air Valve outlets face outward and the Isolating Valves at 45° to Air Valve outlets



Underground Installations

- Underground installations require a venting pipe from the manhole
- Use an angular installation to bypass an obstacle directly above the pipeline.

2.2. Conventions and Measurements

This paragraph presents and explains the terms and measurements used for the Installation process.

D = Diameter of pipeline

d = diameter of riser

H = Height of riser on the pipeline
(Measured from crown of pipeline)

- For pipelines up to 12" (300mm) in diameter (D), the Air Trap diameter (d) should be the same as the pipeline diameter.
- For larger pipelines of up to 60" (1500mm) in diameter (D), the Air trap diameter (d) should be 60% of the pipeline diameter.
- For larger than 60" (1500mm) pipelines (D), the Air trap diameter (d) should be 35% of the pipeline diameter.
- The Air trap length (H) should allow easy access to the air valve from below and should be at least 6" (150mm).

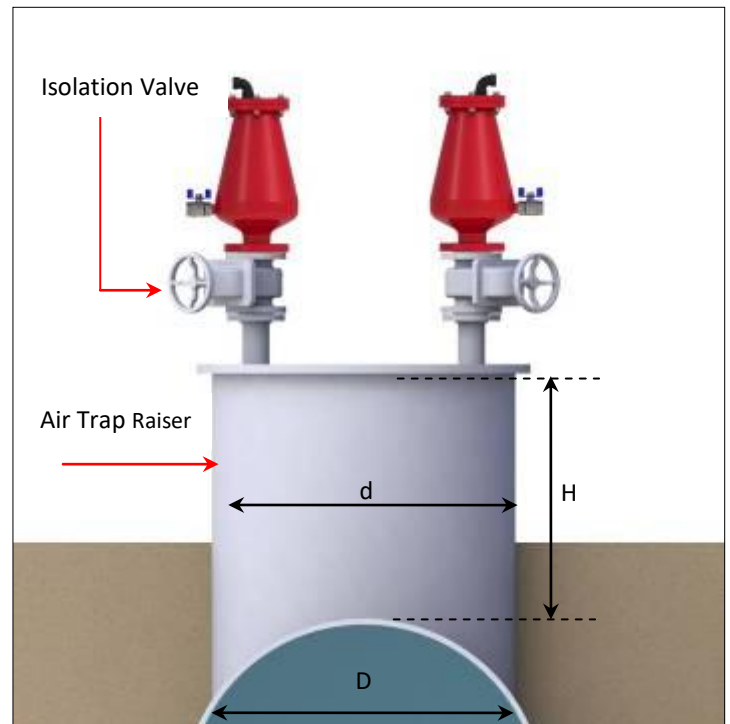

2.3. Installation Instructions

1. Flush the system before installing the air valve to avoid any debris or sharp objects getting into the air valve.
2. Carefully remove the air valve from the shipping package. Unload all air valves carefully to a sturdy level surface taking care not to drop them.
3. Air valves fitted with hoist rings should only be lifted and conveyed using these hoist rings.
4. Install an isolating valve below the air valve, connected by a Riser to the crown of the pipe.
5. Mount the air valve carefully on the rubber gaskets of the isolating valve.
6. Place washers on each of the bolts & nuts that connect the air valve flange to the isolating valve flange.
7. Tighten all the bolts and nuts using the crossover method.
 - a. The closure tightness of the bolts and nuts shall be according to the standard torque for their specific size.
 - b. Use ring wrench keys for the closing and opening of all bolts of the air valve (including the flange bolts).

3. OPERATION

When the system is charged and the pipeline begins to fill, the water flowing in the pipeline enters into the combination air valve, raising the air/ vacuum and air release floats to their sealing position.

During filling, air is discharged mainly through the air/ vacuum orifice as well as small amounts of air released through the air release orifice. As the pipeline becomes fully pressurized, the air/ vacuum orifice will seal and entrapped air will then be automatically released only from the air release orifice.

During pipe draining or water column separation, the floats will drop down due to the vacuum created, and air will enter into the pipeline through the air/ vacuum orifice.

4. TROUBLE SHOOTING

PROBLEM	REASON	SOLUTION
Valve leaking from the Discharge Outlet	<p>A. Low pressure</p> <p>B. Debris caught in sealing mechanism or Rolling Seal is damaged</p>	<p>A. Requires a minimum pressure of 0.05 bar (0.7 psi) to seal properly</p> <p>B. Perform First Stage Maintenance</p>
Valve continues to leak after 1st Stage Maintenance or leak is large	Debris caught in sealing mechanism or Rolling Seal is damaged	Perform Second Stage Maintenance
Leakage from the Ball Valve	<p>A. Ball Valve not completely closed</p> <p>B. Debris caught inside the Ball Valve</p>	<p>A. Tightly close the Ball Valve</p> <p>B. Fully open, then fully close the Ball Valve</p>

5. PERIODIC MAINTENANCE

Please note that the periodic maintenance of the air valve is an integral part of the proper pipeline maintenance regime; it should be maintained at least once a year in accordance with the quality and composition of the fluid in the system.

Important: Before performing any work on the air valve, make sure that all workers on site are familiar with the safety instructions as appear in chapter 1 of this document and with all the relevant local and general safety instructions, standards and work regulations.

5.1. Preparation

5.1.1. Required tools and materials:

- Long-nose Pliers
- Flat-tip screwdriver
- 19mm combination spanner X 2
- 10mm combination spanner
- Plastic head hammer
- Silicon grease



5.2. First Stage Maintenance

Perform when a small leak is detected from the Cover Discharge Outlet and clogging or debris in the sealing mechanism is suspected

5.2.1. Releasing Pressure

- Shut the isolating valve located on the riser under the air valve
- Open the Ball Valve to release pressure and drain the air valve [1]
- Important: Discard liquid to comply with local regulations



5.2.2 Removal of the Sealing Assembly

- Using the two 19mm combination spanners, open and remove the four Bolts, Nuts and Washers [1]
- Store the four Bolts, Nuts and Washers in an accessible area [2]
- Lift and extract the Cover assembly from the valve Body [3]

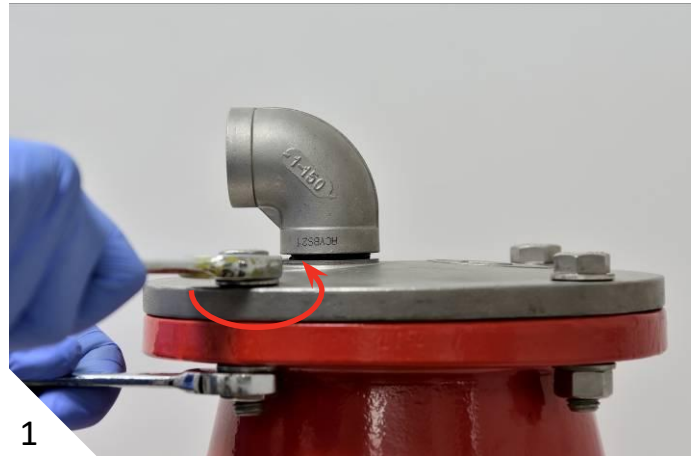

5.2.3. Cleaning of the Sealing Assembly

- Thoroughly wash and clean the Seal Assembly under clean running water to remove all grime [1]. Pay special attention to the internal parts of the Seal Assembly



- Thoroughly clean the body's O-Ring (replace it if needed [2]).

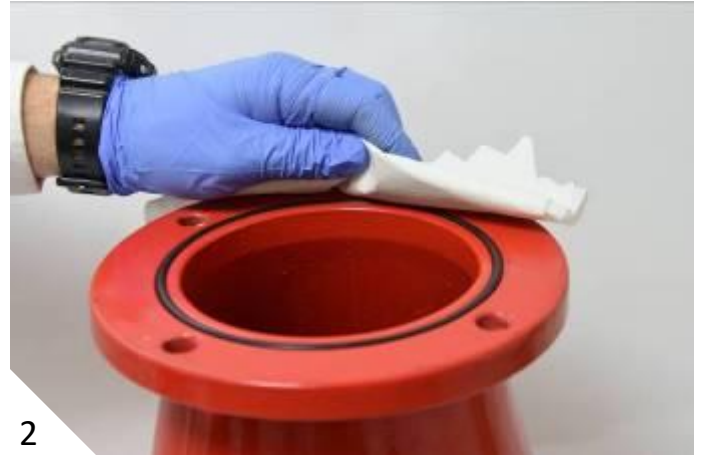

2

5.2.4. Assembly and Testing for Leaks

- Insert the Cover & Float Assembly into the main valve Body [1].
- Insert the four Bolts, Nuts and Washers [2]
- Using the two 19mm combination spanners, tighten using the crossover method [3]
- Close the Ball Valve [4], [5].

Slowly open the isolating valve located on the riser under the air valve.

Look for leaks in the Cover Discharge Outlet. If the air valve still leaks, proceed to: Second Stage Maintenance

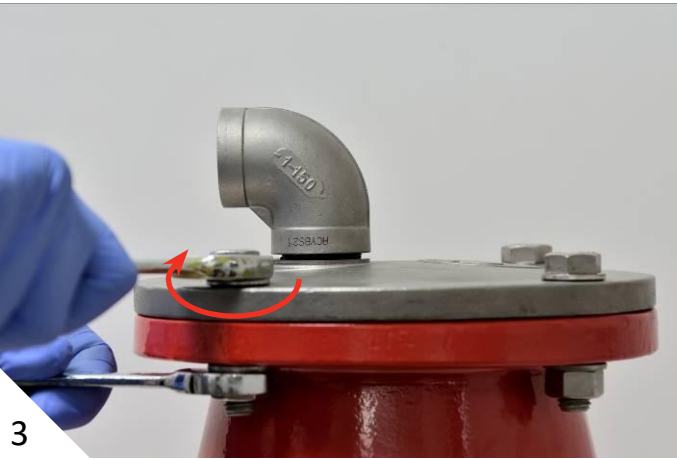

5.3. Second Stage Maintenance

Perform if the first stage doesn't solve the leak, if one of the seals or inner parts need replacement or for periodic maintenance to thoroughly clean the valve.

5.3.1. Releasing Pressure

- Shut the isolating valve located on the riser under the air valve
- Open the Ball Valve to release pressure and drain the air valve [1]
- Important: Discard liquid to comply with local regulations



5.3.2. Disassembly of the Cover Assembly

- Use the plastic hammer to release the Drainage Elbow [1], unscrew and remove it [2].



- Using the two 19mm combination spanners, open and remove the four Bolts, Nuts and Washers [3]
- Store the four Bolts, Nuts and Washers in an accessible area [4]
- Lift and extract the Cover assembly from the valve Body [5]



5.3.3. Disassembly of the Float

- Use the Long-nose Pliers to release and remove the Circlip [1], [2], [3] and [4]

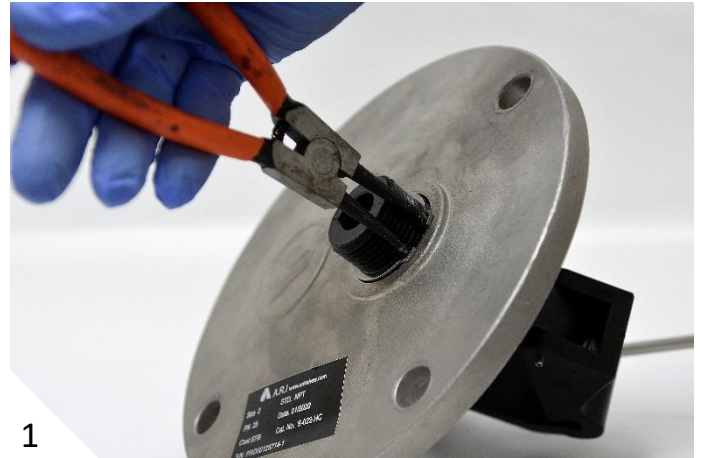

- Use the 10mm combination spanner to disconnect the Float Stem together with the nut, spring and washers from the Nozzle Assembly [1] and [2]

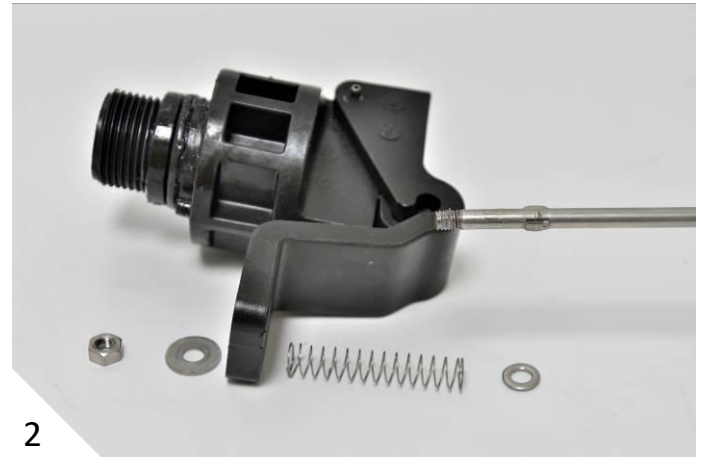

5.3.4. Disassembly of the Rolling Seal

- Locate the Rolling Seal [1] and pull it out, starting from the side marked "A" in pictures [2] & [3].

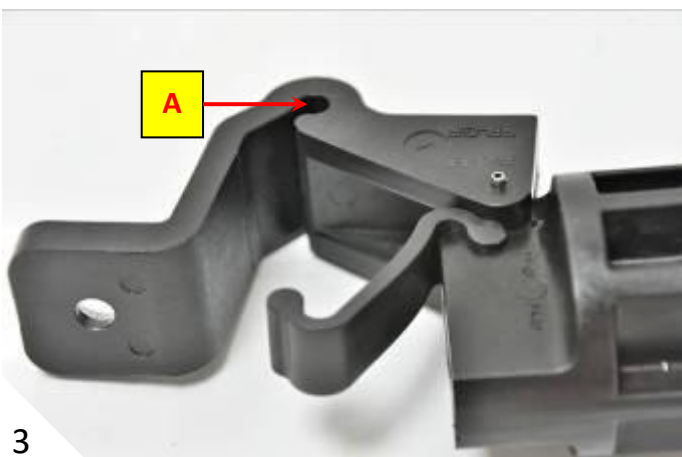

- Pull out the other side of the Rolling Seal from the side marked "B" in picture [4]. Inspect the Rolling Seal and replace it if needed [5].

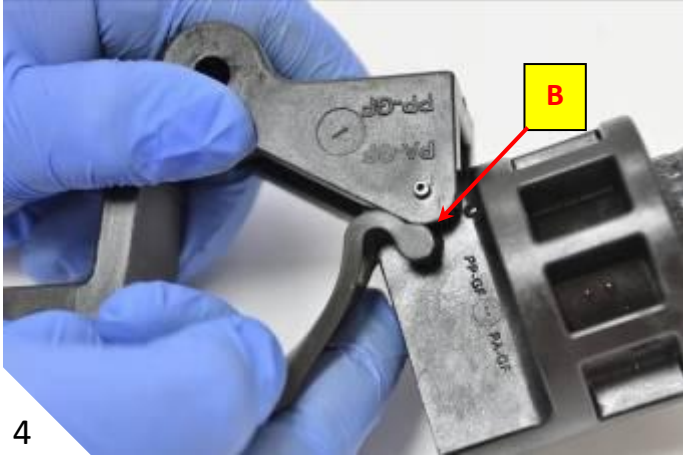

5.3.5. Disassembly of the O-ring

- Locate the O-ring [1] and pull it out using a Flat tip Screwdriver [2]. Inspect the O-ring and if needed replace it.



5.3.6. Reassembling the air valve

- Apply Silicon Grease on the O-ring [1] and re install it to its designated groove in the Nozzle [2].

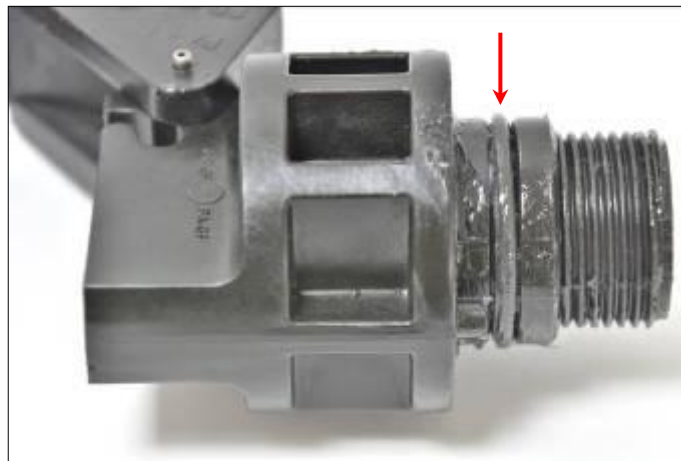
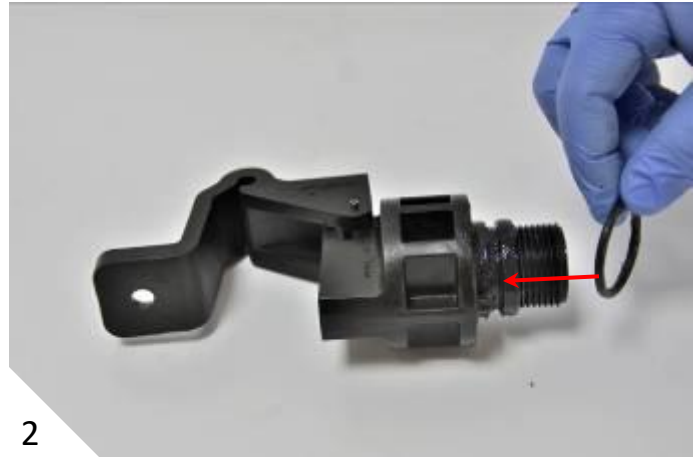

- Apply Silicon Grease on the Rolling Seal [1].



- Reinstall the Rolling Seal in reverse order, first “B” [1] & [2] and then “A” [3] & [4].

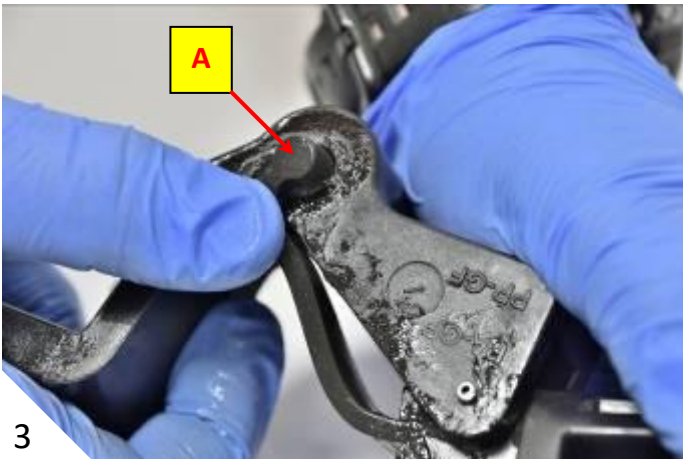
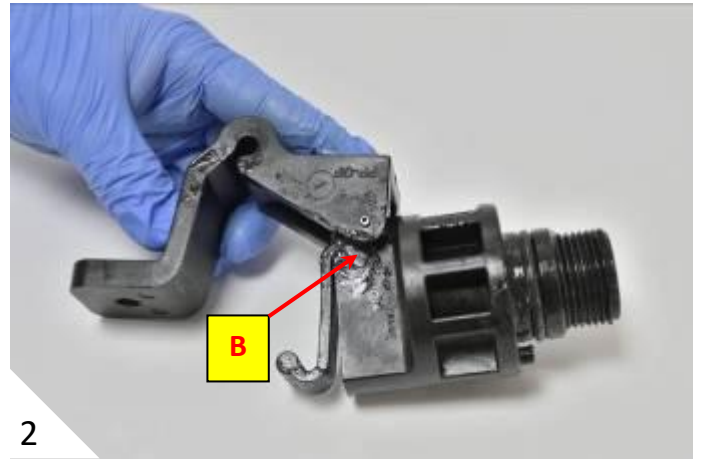

- Make sure that the Rolling Seal is inserted deep enough to port “A” [1] so it is perfectly aligned with the side inserted to port “B” [2].

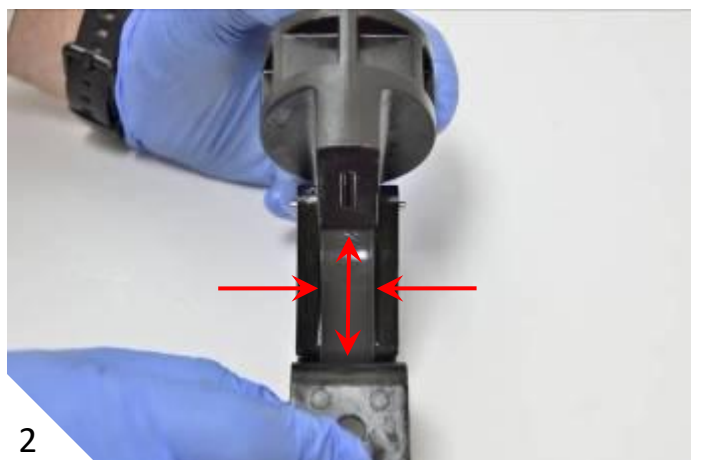

- Reinstall the float rod, spring and washers [1] on the Nozzle Assembly [2].

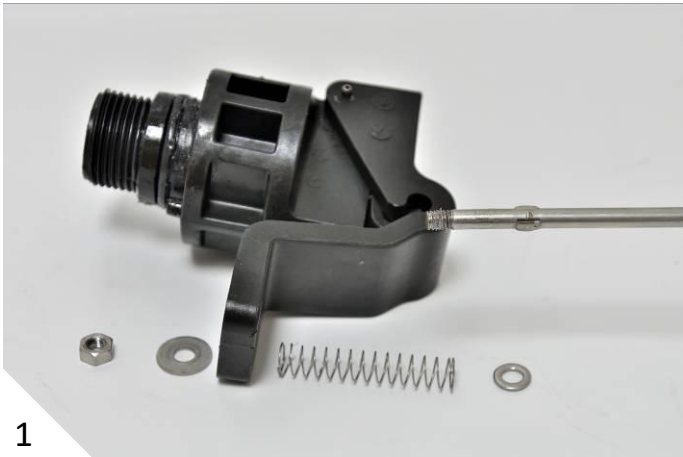

- Reinstall the Stem Assembly to the Air Valve Cover [1]. Make sure that the pin of the Nozzle Assembly is inserted to its designated hole in the cover [2] & [3].



- Use the Long-nose Pliers to install the Circlip [1] and secure the Nozzle Assembly to its place [2] and [3].



- Insert the Float assembly and the cover to the Air Valve Body [1] and screw the cover to the body [2] then reinstall the Discharge Outlet [3].

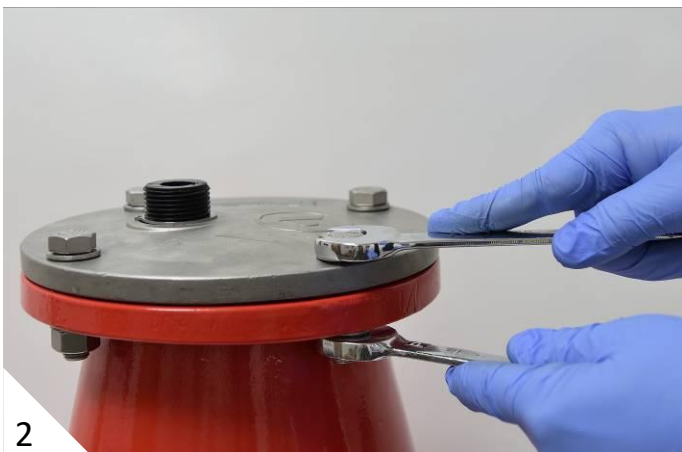



Testing for Leaks

- Close the Ball Valve [1] & [2].



Slowly open the isolating valve located on the riser under the air valve.
Look for leaks in the Cover Discharge Outlet.

6. ASSEMBLY BOM TABLE AND DRAWING

1	Air Release Elbow
2	Circlip
3	Bolt
4	Nut & Washer
5	Cover
6	Air Release Assembly
7	Float Assembly
8	O-Ring
9	Body
10	Ball Valve



1	Nozzle
2	Relief Valve Spring
3	Rolling Seal
4	Lever Seal
5	Roll Pin
6	O-ring
7	Self lock Nut
8	Washer
9	Float Washer
10	Float

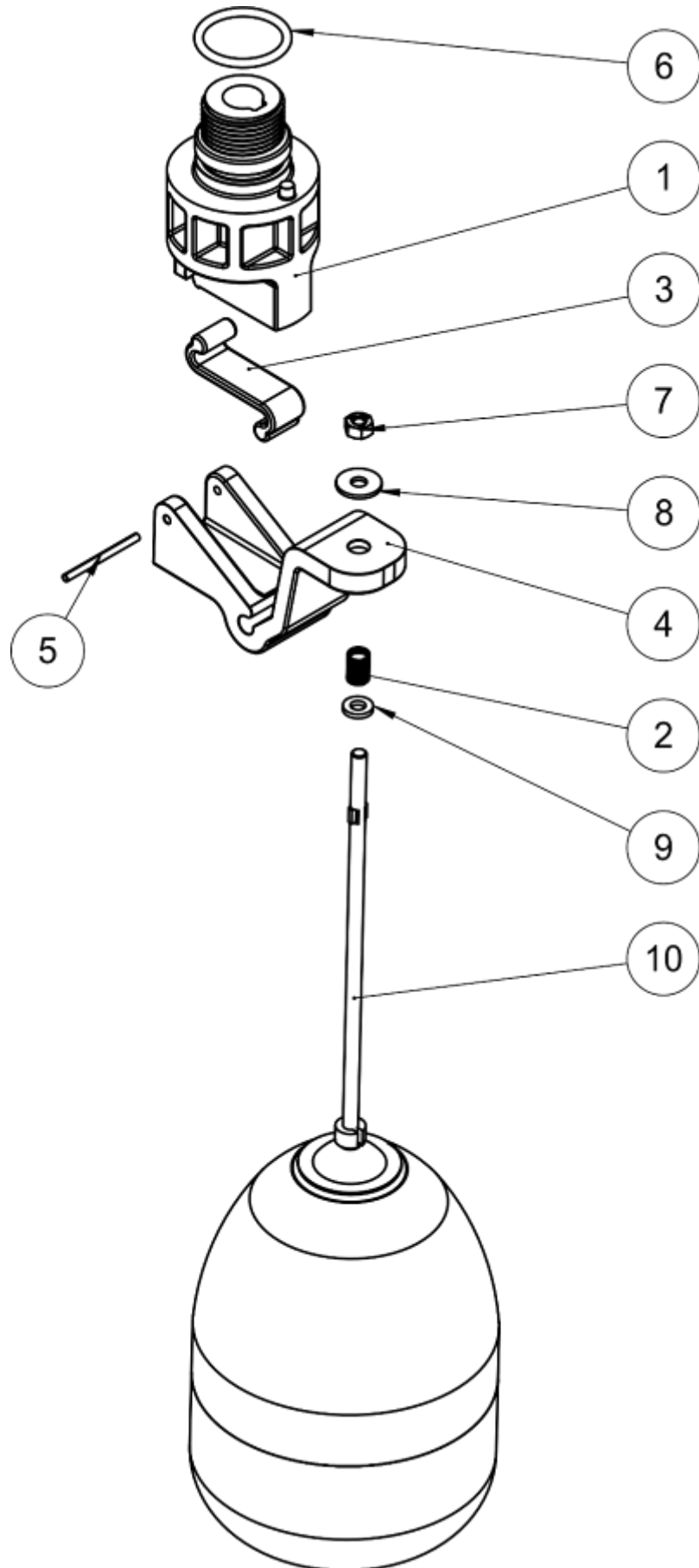

7. A.R.I. LIMITED WARRANTY

A.R.I. Standard International Warranty

A.R.I. manufactured products are guaranteed to be free from defect in material and/or workmanship and to perform as advertised when properly installed, used and maintained in accordance with current instructions, written or verbal.

Should any item prove defective within the time period set forth for that item(s), but in any case not later than within 12 (twelve) months of that product having left A.R.I.'s premises, and subject to receipt by A.R.I. or its authorized representative, of written notice thereof from the purchaser within 30 days of discovery of such defect or failure - A.R.I. will repair or replace or refund the purchase price, at its sole option, any items proven defective in workmanship or material.

A.R.I. will not be responsible, nor does this warranty extended to any consequential or incidental damages or expenses of any kind or nature regardless of the nature thereof, including without limitation, injury to persons or property, loss of use of the products, loss of goodwill, loss of profits or any other contingent liabilities of any kind or character alleged to be the cause of loss or damage to the purchaser.

This warranty does not cover damage or failure caused by misuse, abuse or negligence, nor shall it apply to our products upon which repairs or alterations have been made by other than an authorized A.R.I. representative.

This warranty does not extend to components, parts or raw materials used by A.R.I. but manufactured by others, which shall be only to extent warranted by the manufacturer's warranty.

THERE ARE NO WARRANTIES, EXPRESS OR IMPLIED, EXCEPT THIS WARRANTY WHICH IS GIVEN IN LIEU OF ANY OTHER WARRANTIES, EXPRESS OR IMPLIED, INCLUDING ANY IMPLIED WARRANTY OF FITNESS FOR A PARTICULAR PURPOSE.

(R10822)

A handwritten signature in black ink, appearing to be "Ori Sheffi", written in a cursive style.

Ori Sheffi
C.E.O