

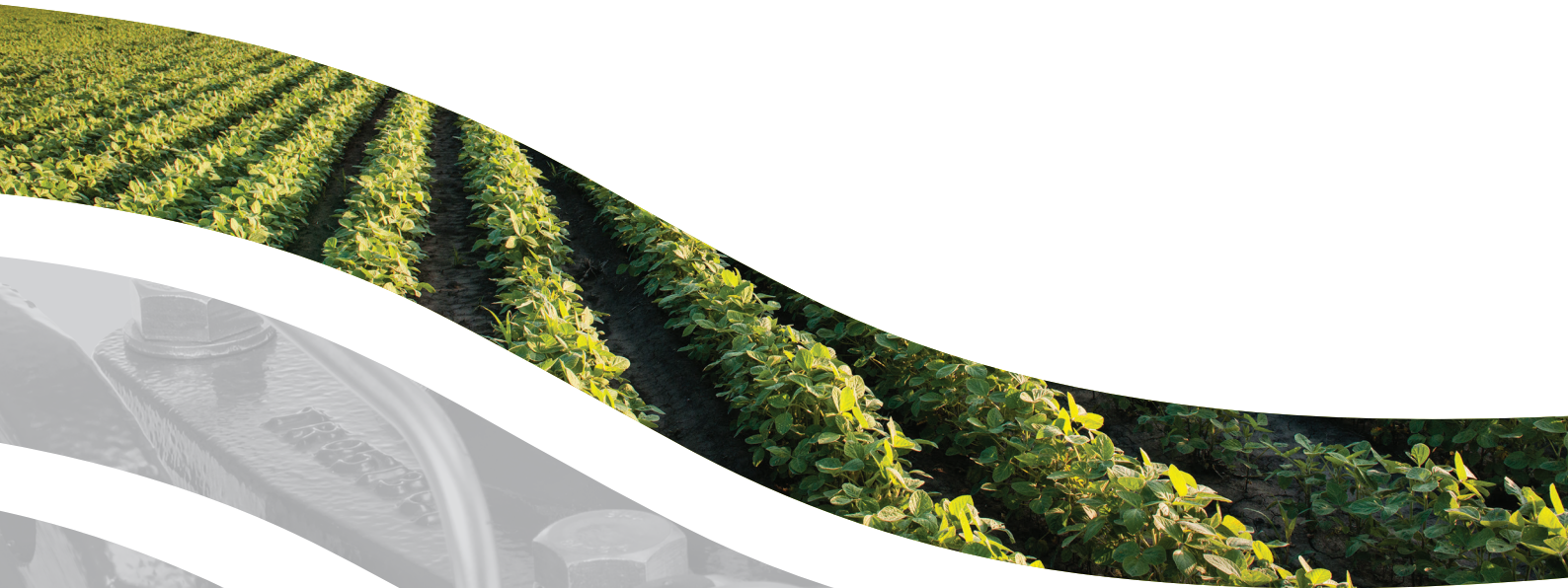

Agriculture Hydraulic Control Valves

R-20 Diaphragm Valves | PN10



AGRICULTURE DIAPHRAGM VALVES [PN10]

R-20 Series

Accurate, Rapid, Reliable and Quiet

The R-20 series is a line of composite material, diaphragm-operated hydraulic control valves with a working pressure up to 10 bar.

The valves are suitable for installation on water transmission, landscape and irrigation systems.

The R-20 series has an innovative elliptic shaped diaphragm that integrates well with a wide variety of regulating control pilots, solenoids and control accessories.

Unique in the R-20 Series

Available in sizes up to 8"

Separate double chamber for 6"-8" valves

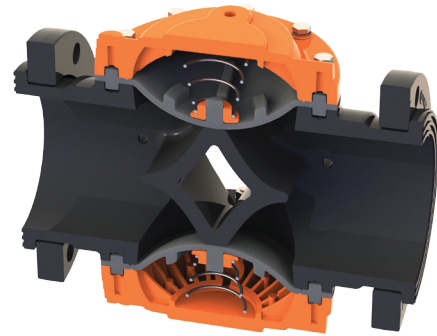

● Excellent regulating capabilities for a wide range of flow rates from drip (500 l/h) up to maximum flow

● Operational from low pressure up to 10 bar

● Highly reliable operation and durable over time

● Quick-reaction operation

● Rapid response to changes in flow rate

● Designed to reduce cavitation damage

● Silent operation

● Low head losses

● Wide range of connections:
Flanged, Threaded and Grooved

● Simple mechanism

● Easy inline maintenance

● User-friendly



R-20 R

Pressure Reducing Control Valve

Maintains a constant downstream pressure regardless of upstream pressure or flow rate fluctuations. The set point of reduced pressure is adjustable by a 2-way or 3-way pilot valve. A spring-loaded diaphragm inside the pilot reacts according to the downstream pressure changes. The pressure fluctuations are compensated by gradual opening and closing of the valve.



R-20 S

Pressure Sustaining Control Valve

The pressure sustaining component maintains the minimum preset upstream pressure regardless of changes in the downstream pressure or in the flow rate. The pressure relief is a sustaining valve that releases excess flow from the system.

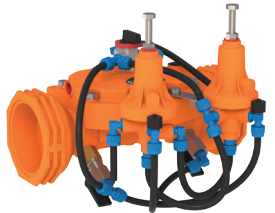

R-20 SR

Pressure Sustaining Reducing Control Valve

The combined operation of the two pilots sustains a constant pressure upstream of the valve, and at the same time, reduces the downstream to a preset pressure. Both pilots have spring-loaded diaphragms. One pilot is sensitive to upstream pressure and the other to downstream pressure. The valve opens or closes gradually to maintain both required pressures simultaneously.



R-22 GE

Electric

Operated Control Valve with Throttling

The electric valves are used for remote commands by solenoids in a normally opened or closed position and can operate in combination with all the hydraulic pilot applications.



R-20 L/X/Y

Level Control Valve

The level control valves are used for a wide range of applications with a horizontal float valve, a vertical (differential) float valve with one or two setting levels or with an altitude P-36 Z hydraulic pilot with adjustable settings, as well as with electric level sensors to match all different water reservoir needs.



R-20 U

Ultra Quick Pressure Relief Control Valve

The valve opens instantly to high pressure readings, but closes slowly to protect the system against excessive pressure.



Hydraulic Pilot Valves

The A.R.I. series of control pilots offers a variety of pressure and flow regulating control pilots, suitable for working pressures from 0.2 bar to 16 bar. This wide range of pilots is suitable for two and three-way control circuits, either in metal or reinforced nylon. The A.R.I. series of control pilots are outstanding in their innovation, accuracy, reliability and simplicity.

Technical Specifications

Size	End Connection	Dimensions (mm)			Weight (Kg)	Control Chamber Volume(ml)	Hydraulic Performance	
		Length	Width	Height			Working Pressure (bar)	Kv
1½" (40 mm)	Threaded	180	140	105	0.7	94	0.5-10	40
2"N (50 mm)	Threaded	190	140	108	0.7	94	0.5-10	51
2"S (50-80-50 mm)	Threaded	237	166	105	1.3	150	0.4-10	91
2"S (50-80-50 mm)	Union (SW)	330	166	116	1.8	150	0.4-10	91
2"S (50-80-50 mm)	Solvent welding	277	166	112	1.6	150	0.4-10	91
2½" (65 mm)	Threaded	259	166	112	1.5	150	0.4-10	91
3"N (80 mm)	Threaded	277	166	121	1.5	150	0.4-10	91
3"N (80 mm)	Grooved	277	166	112	1.3	150	0.4-10	91
3"N (80 mm)	Flanged	282	198	198	3.3	150	0.4-10	91
3"S (80-100-80 mm)	Threaded	310	240	168	3.6	400	0.4-10	240
3"S (80-100-80 mm)	Grooved	310	240	154	3.2	400	0.4-10	240
3"S (80-100-80 mm)	Flanged	315	240	208	4.3	400	0.4-10	240
4" (100 mm)	Threaded	350	240	181	3.9	400	0.4-10	240
4" (100 mm)	Grooved	350	240	166	3.5	400	0.4-10	240
4" (100 mm)	Flanged	356	240	228	7	400	0.4-10	240
6" (150 mm)	Solvent welding	494	339	281	17	2300	0.4-10	542
6" (150 mm)	Flanged	424	339	258	15	2300	0.4-10	542
8" (200 mm)	Flanged	502	340	340	18	2300	0.4-10	607

Suitable for 1½" - 4"

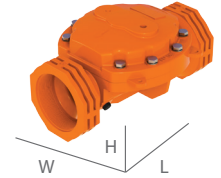

Suitable for 6" - 8"

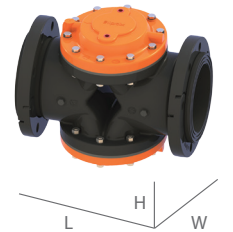

$Kv = Q / \sqrt{\Delta P}$ Where Q=Flow Rate (m³/h), ΔP=Pressure loss across the valve (bar), when fully open

Cavitation Data

Determining safe operating pressure drop conditions

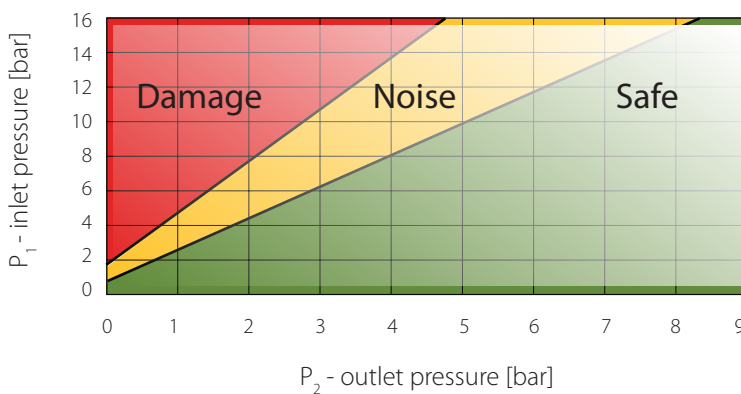

$$\sigma_{system} = \frac{P_1 - P_{vapor}}{P_1 - P_2}$$

Where

σ = Cavitation number [no units],

P = Absolute pressure [either unit are acceptable; e.g.: bar/mwc/psi]

* Operating conditions inside the cavitation damage zone is permissible for infrequent periods of short duration.

* Based on cavitation index (sigma values) as defined by Utah State University Water Research Laboratory.

* Operating conditions, at standard temperature and elevation.

Flow Charts

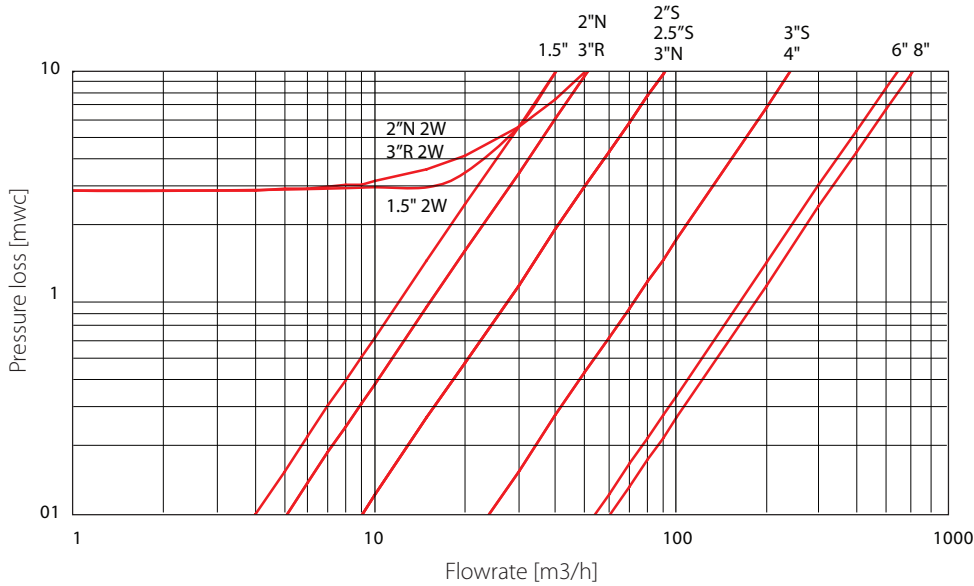

Diaphragm Working Pressure

Diaphragm Model	Working Pressure
Low pressure	0.2 - 5 (bar)
Default	0.4 - 10 (bar)



* Other diaphragm materials available on request

Bolts tightening

Size	Recommended Torque [Nm]	
	Min.	Max.
1.5" - 2"	4	4
2" S - 3"	12	15
3" S - 4"	25	30
6" - 8"	25	30



A.R.I. is a leading manufacturer and provider of solutions for the protection and control of liquid transmission systems. The company manufactures and markets its world renowned comprehensive line of air valves, check valves, and unmeasured flow reducers as well as exceptional performance hydraulic control valves. A.R.I. is known throughout the world for its expertise, service and uncompromising quality – A.R.I. Redefining Reliability

Control Valve Applications



Standards & Approvals

